

04.2009 TR30A063 RE

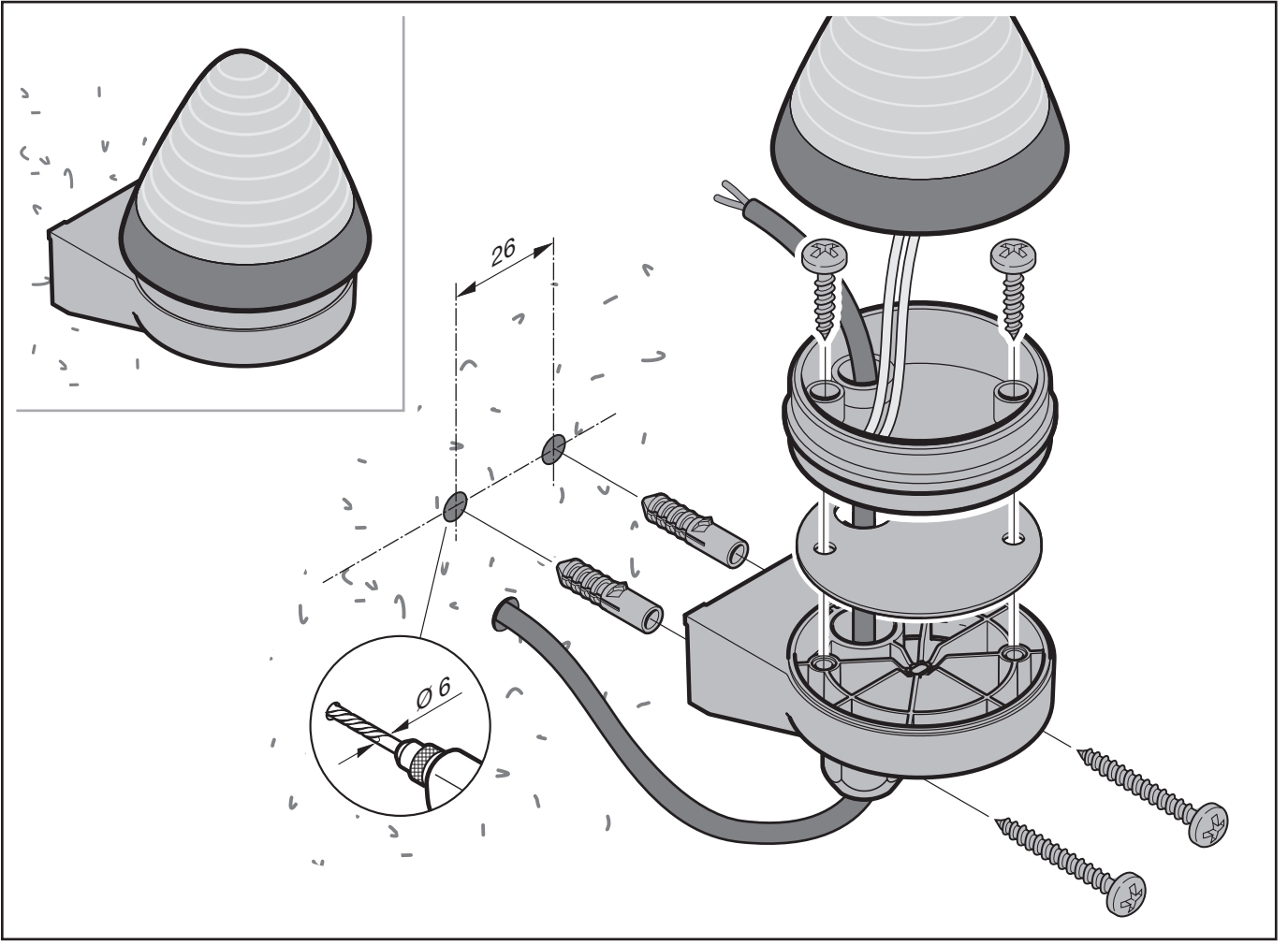

04.2009 TR30A063 RE

